

INDUSTRIAL MACHINES

NEW! Industry 4.0 ready

Lap Joint Tee Forming

	Average	Weeks
S-56	\$156,000	Stock / 10
S-56 MFT	\$203,000	12
S-56 AFT	\$250,000	14
S-80	\$390,000	24

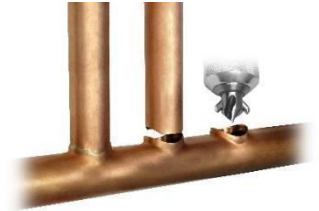

Chip-less Tube Cutting

TCC-50 MCS	\$115,000	14
TCC-28 coil	\$302,000	Stock / 14
TCC-28 RL	\$328,000	16
TCC-50 RL	\$328,000	16
Flying Cut-Off	\$334,000	38



Cutting and End Forming

TCC-45-EF3	\$390,000	24
TCC-45-EF8	\$505,000	28



Tube End Spinning

SP-110	\$156,000	Stock / 14
SPM-115	\$193,000	20



Butt-Weld Tee Forming

T-115	\$135,000	Stock / 10
TEC-220 SCH10	\$302,000	12
TEC-220 SCH40	\$370,000	Stock / 12
SEC-100 TBC	\$749,000	28
PLUS-500	\$864,000	38
CEC-170	\$1,560,000	38
T-850	\$2,236,000	38



Flanging

F-170	\$179,000	20
F-200	\$338,000	22
F-200 HOT (Gas)	\$416,000	22
F-420E Induction Heat	\$614,000	26
F-600	\$1,113,000	34



Above Industrial machine prices are budgetary, estimate based on average customer setup with tooling.

ORDER ONLINE AT WWW.T-DRILL.COM/SHOP

T-DRILL INDUSTRIES INC. • 1740 Corporate Drive#820, NORCROSS, GA 30093 • 770-925-0520 • SALES@T-DRILL.COM

1/5/2023

**PORTABLE COPPER TEE FORMING
Braze Lap-Joint**

Trade-In older unit

-\$1000

T-35 COMPLETE PACKAGE

#5330640

\$8,200

OUTLET SIZES: 1/2" - 1 1/4"

RUN TUBE: 1/2" - 2 1/2"

INCLUDES:

- T-35 Drive Unit
- ND-54 Tube End Notcher
- Four Nominal T-DRILL Heads
 - 1/2", 3/4", 1", 1 1/4"
- Carrying Case
- Gauge Block
- T-DRILL Lubricant
- Hex Wrenches
- Training CD and Manual

T-35 MEASUREMENTS: 25"x16"x5" 53lbs



T-65 COMPLETE PACKAGE

#5330677

\$11,100

OUTLET SIZES: 1/2" - 2"

RUN TUBE: 1/2" - 4"

INCLUDES:

- T-65 Drive Unit
- ND-54 Tube End Notcher
- Six Nominal T-DRILL Heads
 - 1/2", 3/4", 1", 1 1/4", 1 1/2", 2"
- Counter Plate
- Carrying Case
- An Assortment of Sizing Gauges.
- T-DRILL Lubricant
- Hex Wrenches
- Training CD and Manual

T-65 MEASUREMENTS: 25"x16"x5" 62lbs



T-65B (Battery) COMPLETE PACKAGE

#5330685

\$11,700

OUTLET SIZES: 1/2" - 2"

RUN TUBE: 1/2" - 4"

INCLUDES:

- T-65B 28V Drive Unit
- 28V 3amp-hour Lithium-ion Battery
- Charger
- ND-54 Tube End Notcher
- Six Nominal T-DRILL Head
 - 1/2", 3/4", 1", 1 1/4", 1 1/2", 2"
- Counter Plate
- Carrying Case
- An Assortment of Sizing Gauges.
- T-DRILL Lubricant
- Hex Wrenches
- Training CD and Manual

T-65B MEASUREMENTS: 25"x16"x5" 70lbs



T-35 / T-65 Cu SPARE PARTS AND SERVICES

A	T-35 Drive Unit	#5330624	\$3,127
A	T-65 Drive Unit	#5330678	\$4,562
A	T-65b (Battery) Drive Unit	#5330688	\$6,102
B	Nd-54 Tube End Notcher	#5090294	\$3,265
C	Copper Lube (19oz)	#3160000	\$52
D	4" Counter plate	#5540085	\$319
E	Gauge Ring 1-1/4"	#4050165	\$46
E	Gauge Ring 1-1/2"	#4050166	\$55
E	Gauge Ring 2"	#4050167	\$78
F	T-65 Carry Case	#5330166	\$457
F	T-65B Carry Case	#5330692	\$461
F	T-35 Carry Case	#5330631	\$482
G	Milwaukee Cord	#48-76-4008	\$56
H	Collar Gauge (Up to 1")	#3310422	\$137
I	Lube Applicator	#5300117	\$56
J	28v Lithium-Ion Battery	#8001897	\$229
K	120v Battery Charger	#8001898	\$62
	OTHER:		
	T-65 6" Tube Support	#5540120	\$625
	Head Resharpening	DCSHARPEN	\$95



Collaring Head	Nominal	O.D.	Whole Collaring Head	Drill Core	Forming Pins			
	1/4"	3/8"	5310399	\$357	2310140	\$304	3310468	\$90
	3/8"	1/2"	5310400	\$357	2310150	\$313	3310469	\$114
	1/2"	5/8"	5310401	\$400	2310160	\$317	3310470	\$160
	5/8"	3/4"	5310402	\$391	2310170	\$338	3310470	\$160
	3/4"	7/8"	5310403	\$437	2310180	\$368	4310473	\$186
	1"	1 1/8"	5310404	\$437	2310210	\$401	4310474	\$216
	1 1/4"	1 3/8"	5310411	\$712	4310221	\$447	3430033	\$314
	1 1/2"	1 5/8"	5310412	\$743	4050253	\$483	3430033	\$314
	2"	2 1/8"	5310413	\$810	2050254	\$534	3430034	\$314

ORDER ONLINE AT WWW.T-DRILL.COM/SHOP

**COPPER MANIFOLDS
Brazen Lap-Joints**

HFT-2000 Cu

OUTLET SIZES: ½ - 2"

RUN TUBE: 1"- 4"

MAX WORKING LENGTH: 78.5"

HFT-2000 Shipping Crate: 102"x26"x21" 450 lbs

(T-65 package sold separately)

#5080158

\$23,200



HFT EXTENSION PIECE +78.5" Cu

Converts HFT table to a 158" length table.

HFT Digital Scale required.

#5080060

\$8,314

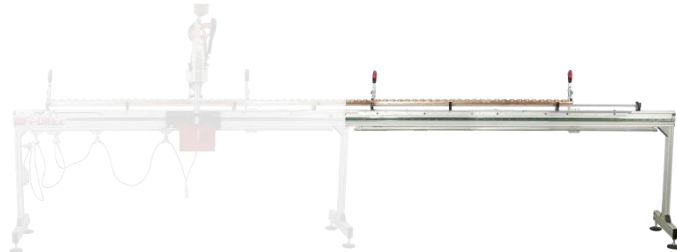

HFT Digital Scale Cu

Required with HFT Extension.

#5080152

\$2,698



HFT Rotary Module Cu

Allows 15-degree increment rotation of the tube. Each main tube size needs a dedicated Insert.

#5080176

\$4,858

- Rotary Pipe Insert < 1.25 O.D.
- Rotary Pipe Insert >= 1.25 O.D.

Inform of needed sizes

\$585 / size

Inform of needed sizes

\$931 / size



LARGE COPPER TEE FORMING Brazen Lap-Joint

PLUS-115 Cu BASIC PACKAGE

#5700312

\$21,100

OUTLET SIZES: 2" - 4"

RUN TUBE: 2½" - 8"

INCLUDES:

- Locking Levers for Clamps.
- A Base Plate.
- Lead Screw Assembly.
- Pilot Hole Drill.
- Tilt Rod Assembly.
- Sizing Gauge.
- Double Dimpler.
- Two Carrying Cases
- T-DRILL Lubricant
- Hex Wrenches
- Training CD and Manual



PLUS-115 MEASUREMENTS:

- 24"x13"x12" 62lbs
- 24"x13"x12" 68lbs

Basic package does **NOT** include T-65 drive unit or tooling.

Choose from below a drive unit if not already have one.

Collaring heads for outlet sizes and dedicated main pipe clamps for each size of the main.

T-65 DRIVE UNIT

(If not already have one)

#5330678

\$ 4,562

COLLARING HEADS

Collaring Head No. 1 (2.125" – 3")

Collaring Head No. 2 (3" – 4.25")

#5700067

#5700075

\$ 4,141

\$ 4,327



PLUS-115 Cu RING CLAMPS

- Ring clamps are changed every time when run tube diameter is changing (=One set for each tube O.D.)

Part Number	Nominal Copper Tube	O.D. INCH	O.D. mm	Price
4290188	2"	2.125	53.9	\$1,431
4290194	2½"	2.625	66.7	\$1,431
4290195	3"	3.125	79.67	\$1,431
4290196	4"	4.125	104.8	\$1,586
4290184	6"	6.125	152.4	\$1,586
4291295	8"	8.125	203.2	\$1,878

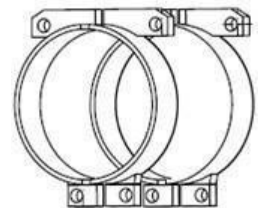

Other sizes available by request

STAINLESS STEEL TEE FORMING Butt-Welds

T-65SS BASIC PACKAGE

#5330809

\$9,500

OUTLET SIZES: 3/4" - 2"

RUN TUBE: 1" - 4"

INCLUDES:

- T-65 Unit
- Counter plate
- Tilt rod assembly
- Pilot hole drill chuck
- Facing tool
- Lubricant
- Carrying case
- Training video



T-65B MEASUREMENTS: 25"x10"x13" 50lbs

Basic package does **NOT** include tooling.
Choose from below needed tooling for each outlet size.

Tooling for 3/4" O.D. Tube tees	9990900	\$759
Tooling for 7/8" O.D. Tube tees	9990901	\$794
Tooling for 1" O.D. Tube tees	9990902	\$864
Tooling for 1 1/4" O.D. Tube tees	9990903	\$951
Tooling for 1 1/2" O.D. Tube tees	9990904	\$1,030
Tooling for 2" O.D. Tube tees	9990905	\$1,156

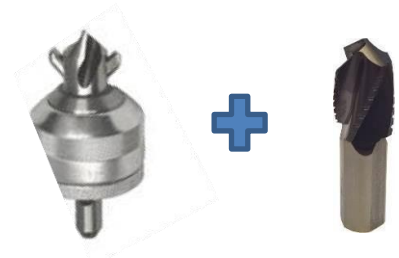

T-65SS SPARE PARTS:

Pilot Hole Drill Bit – 17.2mm - 3/4" O.D. tube	6310558	\$244
Pilot Hole Drill Bit – 21.3mm - 7/8" O.D. tube	6310552	\$244
Pilot Hole Drill Bit – 26.9mm - 1" O.D. tube	6310553	\$283
Pilot Hole Drill Bit – 33.7mm - 1 1/4" O.D. tube 42.4mm - 1 1/2" O.D. tube	6310554	\$359
Pilot Hole Drill Bit – 48.3mm - 2" O.D. tube	6310555	\$345



Collaring Head – 17.2mm - 3/4" O.D. tube	5050087	\$508
Collaring Head – 21.3mm - 7/8" O.D. tube	5050111	\$542
Collaring Head – 26.9mm - 1" O.D. tube	5050116	\$573
Collaring Head – 33.7mm - 1 1/4" O.D. tube	5050121	\$635
Collaring Head – 42.4mm - 1 1/2" O.D. tube	5050126	\$714
Collaring Head – 48.3mm - 2" O.D. tube	5050129	\$786



Facing Blade	4120157	\$104
Brush	9011602	\$16
SS Lubricant – 16 Oz.	9010006	\$57
T-65ss Carry Case	5330710	\$418

ORDER ONLINE AT WWW.T-DRILL.COM/SHOP

T-65SS OPTIONAL ACCESSORIES:

BALL PULL PACKAGE for T-65 SS
OUTLET SIZES: ½" - 1"

#5330901

\$3,195

Includes:

- Ball Pull Tool
- Ball setter bar
- M6 Threaded bar (3 pcs)
- M8 Threaded bar (3 pcs)



(Tooling sold separately, choose from below needed tooling)

Tooling:



Collar I.D 10mm-12.7mm INCHES

- Specified ball size to application
- 6.2mm Pilot hole drill bit

**Pulling Ball
#6310719**

**\$757
\$172**

Collar I.D 12.7mm-20mm

- Specified ball size to application
- 8.2mm Pilot hole drill bit

**Pulling Ball
#6310720**

**\$757
\$216**

Collar I.D 20mm-25.8mm

- Specified ball size to application
- 10.2mm Pilot hole drill bit

**Pulling Ball
#6310721**

**\$757
\$292**

BALL PULL SPARE PARTS:

Ball pull tool	5330712	\$2,949
Chuck for drills, including key	5330785	\$306
Ball setter rod	6330709	\$191
M6/M8 threaded bars for ball sizes 10 mm – 12.7 mm	6330715	\$49
M8 threaded bars for ball sizes 12.7 mm – 25.8 mm	8002702	\$19
Ø 6,2mm drill for Ø I.D 0.394" – 0.472" collars	6310719	\$179
Ø 8,2mm drill for Ø I.D 0.472" – 0.787" collars	6310720	\$216
Ø10,2mm drill for Ø I.D 0.787" – 1" collars	6310721	\$292

STAINLESS STEEL MANIFOLDS
Butt-Welds

HFT-2000 SS Stainless Steel

#5080215

\$36,200

OUTLET SIZES: 3/4" - 2"

RUN TUBE: 1" - 4"

MAX WORKING LENGTH: 78.5"

HFT-2000 Shipping Crate: 102"x26"x21" 500lbs

(T-65SS package sold separately)



HFT EXTENSION PIECE +78.5" SS

#5080265

\$8,314

Converts HFT table to a 158" length table.

HFT Digital Scale required.

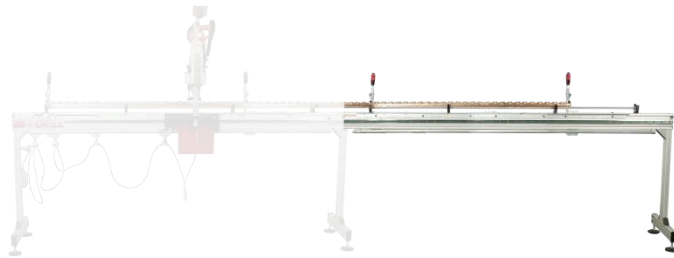

HFT Digital Scale SS

#5080217

\$2,698

Required with HFT Extension.



HFT Rotary Module ss

#5080241

\$6,676

Allows 15-degree increment rotation of the tube. Each main tube size needs a dedicated Insert.

- Rotary Pipe Insert < 1.25 O.D.
- Rotary Pipe Insert >= 1.25 O.D.

Inform of needed sizes

\$585 / size

Inform of needed sizes

\$991 / size



LARGE STAINLESS-STEEL TEE FORMING Butt-Welds

PLUS-115 SS BASIC PACKAGE

#5700311

\$29,400

Basic package Includes:

- -PLUS-115 attachment
- -Base plate
- -Tilt rod
- -Pilot hole drill (elliptical holes)
- -Trimming tool
- -Lead screw
- -Locking levers, 2 pcs for ring clamps
- -Carrying cases, 2 pcs
- -Pedal
- -Documents

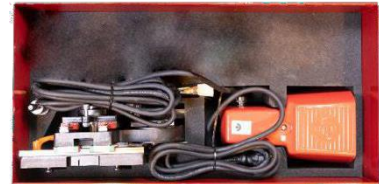
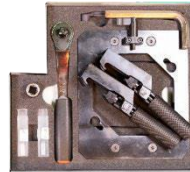

*Basic package does **NOT** include T-65 drive unit or tooling.*

Choose from below a drive unit if not already have one,

Collaring heads for outlet sizes and dedicated main pipe clamps for each size of the main.

T-65 DRIVE UNIT

#5330678

\$ 4,562

COLLARING HEADS FOR STAINLESS STEEL

Collaring Head No. 1 (2" – 3.5")

#5700148

\$ 4,942

Collaring Head No. 2 (3.35" – 4.5")

#5700150

\$ 5,253

PLUS-115 SS RING CLAMPS:

One clamp set for each run tube diameter.

Part Number	NPS	O.D. Tubing	O.D. INCH	O.D. mm	Price
4290167	2		2.37	60.3	\$1431
4290168		2 1/2	2.50	63.5	\$1431
4290169		2 3/4	2.76	70	\$1431
4290170	2 1/2		2.87	73	\$1431
4291290		3	3.00	76.2	\$1431
4290172		3 1/4	3.25	82.5	\$1431
4290173	3	3 1/2	3.50	88.9	\$1431
4290174	3 1/2	4	4.00	101.6	\$1431
4290175		4 1/4	4.25	108	\$1586
4290176	4	4 1/2	4.50	114.3	\$1586
4291665		4 3/4	4.72	120	\$1586
4290183	4 1/2	5	5.00	127	\$1586
4290237		5 1/4	5.24	133	\$1586
4290177		5 1/2	5.50	139.7	\$1586
4290178	5		5.56	141.3	\$1586
4290184		6	6.00	152.4	\$1586
4290179	6		6.63	168.3	\$1878
4291295		8	8.00	203.2	\$1878
4290230	8		8.63	219.1	\$1878
4290329		10	10.00	254	\$2398
4291669	10		10.75	273	\$2398

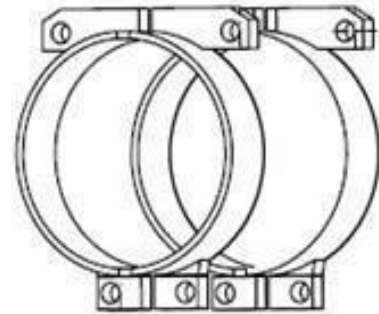

Other sizes available by request

PLUS-115SS SPARE PARTS:

9010006	Lubricant 16oz	\$57
6310552	Pilot hole drill bit	\$244
4120156	Reversible blade	\$132

ORDER ONLINE AT WWW.T-DRILL.COM/SHOP

HANDS ON & VIRTUAL TRAINING

Training and certification are mostly done online thru www.t-drill.com/certification.
If additional training is required, see below for additional options.

Training in your facility includes **\$3,750**
Travel and all expenses; one (1) day is required with this system.

Training Virtually includes **\$535**
Online training through your preferred video meeting platform

TERMS AND CONDITIONS**T-35, T-65, T-65SS & PLUS-115 PACKAGE:**

Shipment: Ships from Norcross, GA. Packages include domestic ground freight.

Terms of payment: Paid in advance: Wire transfer (\$45 fee), Check in advance or Credit Card (2.89%fee).

Financing: 3rd Party financing available through Complete Capital Services
www.completecapitalservices.com Phone:586-778-6800

Returns: 25% Restocking fees, all returns require prior authorization.

Delivery time: Packages are in normally in stock, delivered via Norcross, GA. Requires signature upon arrival.

Price Validity: These prices are valid for 30 days. General price increase happens at the beginning of each fiscal year, but subject to change.

Warranty: One (1) year warranty against defects in materials and workmanship, not including normal wear items based on one (1) shift production.

HFT:

Shipment: FOB Shipping via Norcross, GA on a pallet. Customer arranges pickup.

Terms of payment: Paid in advance: Wire transfer (\$45 fee), Check in advance or Credit Card (2.89%fee).

Financing: 3rd Party financing available through Complete Capital Services
www.completecapitalservices.com Phone:586-778-6800

Returns: 25% Restocking fees, all returns require prior authorization.

Delivery time: HFT's are in normally in stock, delivered via Norcross, GA.

Price Validity: These prices are valid for 30 days. General price increase happens at the beginning of each fiscal year, but subject to change.

Warranty: One (1) year warranty against defects in materials and workmanship, not including normal wear items based on one (1) shift production.